

# パネルインターフェース

## 技術情報

材質：PC

保護等級：IP54

温度範囲：-20...+70°C



SVL-PURD-T3



SVL-PURD



SVL-MP



SVL-MCP

# パネルインターフェース

## 大型パネル

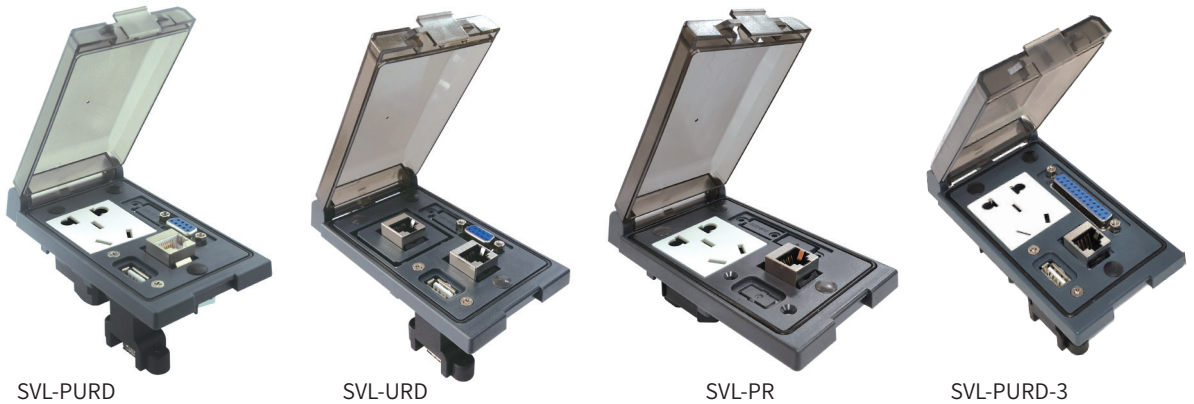

型式	9145209	9145209T2	9045209	9145000	9145225
型番	SVL-PURD	SVL-PURDT	SVL-URD	SVL-PR	SVL-PURD-3
インターフェース					
10A コンセント電源	1	1 (注3)	/	1	1
RJ45 ネットワーク CAT6 (注1)	1	1	2	1	1
USB 3.0	1	1	1	/	1
D-SUB-9 (注2)	1	1	1	/	/
D-SUB-25 (注2)	/	/	/	/	1

備考：

注1：RJ45 ポートは標準品は CAT6, CAT6<sub>a</sub> が必要な場合はご連絡ください。

注2：D-SUB-9 を D-SUB-15 に変更可能。品番：9145215、9045215。

注3：ユニバーサルコンセント

全体寸法

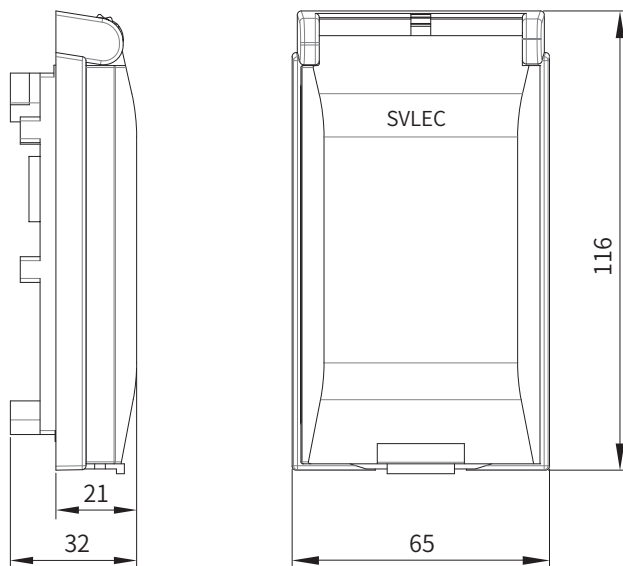

カットアウト寸法  
(このページの製品に適用)

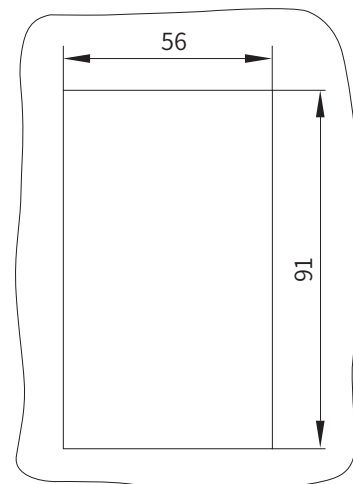

# パネルインターフェース

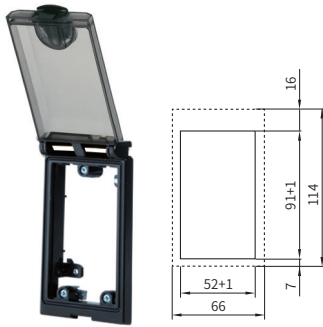

型番：SVL-A1  
品番：9100002



型番：SVL-A2  
品番：9100003



インターフェース	電源 +2RJ45	電源 +RJ45+USB	電源 +2USB	電源 +2RJ45	電源 +RJ45+USB	電源 +2USB
型番	MB-CP2R	MB-CPRU	MB-CP2U	MB-AP2R	MB-APRU	MB-AP2U
型式	9124500	9114513	9100023	9224500	9214513	9200023

インターフェース	電源 +2RJ45	電源 +RJ45+USB	電源 +2USB	4RJ45	2RJ45+2USB	4USB
型番	MB-EP2R	MB-EPRU	MB-EP2U	MB-4R	MB-2R2U	MB-4U
型式	9324500	9314513	9300023	9044500	9024523	9000043

インターフェース	2RJ45+D-SUB9	RJ45+USB+D-SUB9	2USB+D-SUB9	2RJ45+D-SUB25	RJ45+USB+D-SUB25	2USB+D-SUB25
型番	MB-2RD9	MB-RUD9	MB-2UD9	MB-2RD25	MB-RUD25	MB-2UD25
型式	9245001	9145131	9000231	9245003	9145133	9000233

上記製品は、RJ45 が CAT 6、USB が 3.0 です。

# パネルインターフェース

## 小型パネル



型式	9200000	9200000T	9045115
型番			
インターフェース	SVL-MP	SVL-MPT	SVL-MCP
Aタイプコンセント電源 (10A)	1	/	/
ユニバーサルコンセント電源 (20A)	/	1	/
RJ45ポート (注1)	/	/	1
USB 3.0	/	/	1
D-SUB-9 (注2)	/	/	1

備考：

注1：RJ45ポートは標準品はCAT6, CAT6<sub>A</sub>が必要な場合はご連絡ください。

注2：D-SUB-9をD-SUB-15に変更可能。品番：9045116。

全体寸法

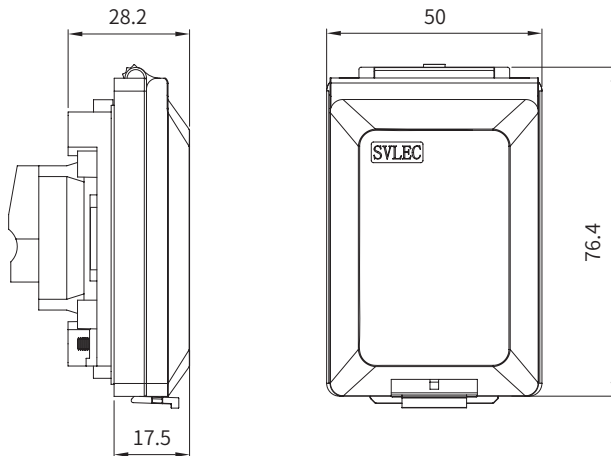

カットアウト寸法  
(このページの製品に適用)

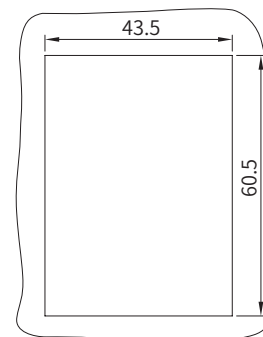

# パネルインターフェース

## 取付手順

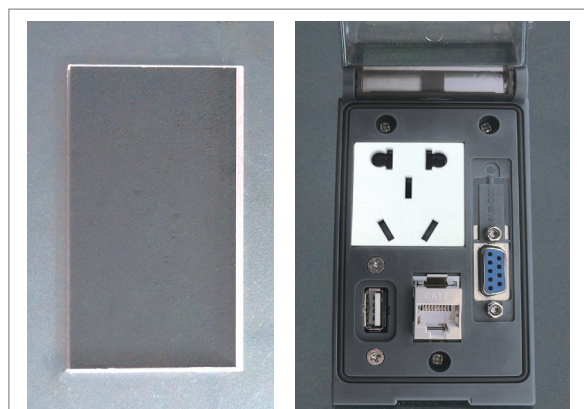

① MSDD を切り込みにセットします

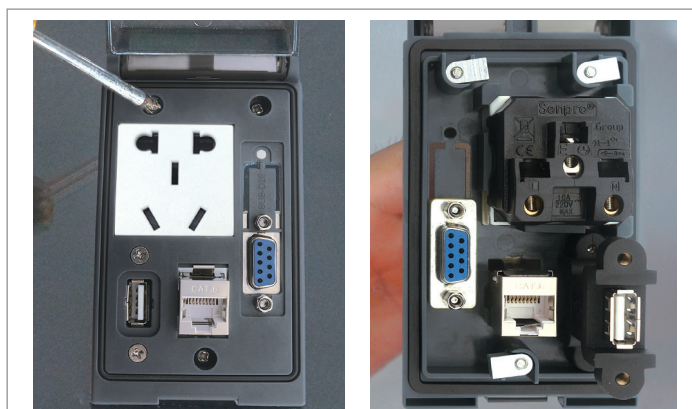

② ネジを緩めます



③ ナットの位置を調整します





④ しっかりとネジを締めます

### 説明：

1. ネジ山の一部には潤滑液が塗布されており、ネジ（No.2）を2～3周緩めると、ネジとナットが一緒に回転し、ナット位置（No.2）を調整することができます。

2. 締め付けトルクは0.5Nm以下。

# フロントパネルコネクタ

インターフェース	RJ45 ポートアダプター CAT6A	RJ45 プラグポート	USB 3.0 コネクタ用
			
型式	999096	999095	999102

インターフェース	RJ45 コネクタ + IDC 接続付き	RJ45 ハウジング	プッシュプル式電源コネクタ	プッシュプル式電源ハウジング	
					
極数	4 芯	8 芯	5 芯	5 芯	
型式	9452210401	9452230401	9452250311	9354310401	9354310311
技術情報	CAT5e, AWG22	CAT6A, AWG26	CAT6A	24V, 16A, スプリング配線 0.5-2.5mm <sup>2</sup>	

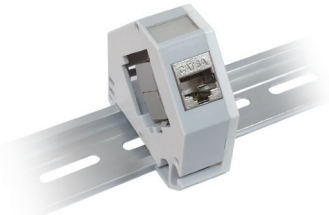
インターフェース	RJ45 レール取り付け用 RJ45
	
型式	999093

インターフェース	RJ45 防水コネクタ (CAT 6A IP68)	盤内外接続用 RJ45	
			
説明		ソケット	フランジベース
型式	999092	999193	999190

説明	現場組立式 RJ45 オスシールドコネクタ、CAT6A	現場組立式 RJ45 オスシールドコネクタ、CAT 5e	現場組立式 RJ45 オスシールドコネクタ、CAT 5e		
					
極数	4 芯 IP20	8 芯 IP20	4 芯 IP20		
型式	999051	999181	999061	999071	999161

# フロントパネルコネクタ

寸法 (mm)

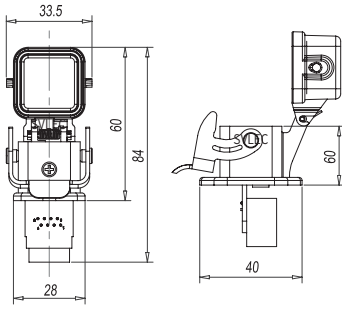

RJ45 ハウジング

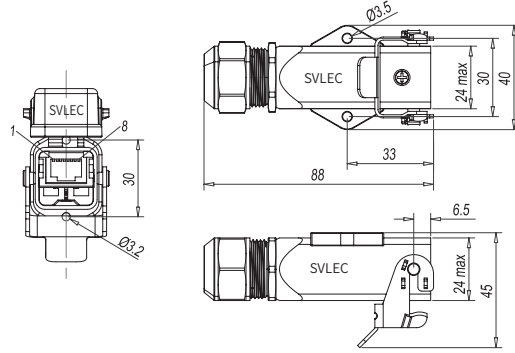

RJ45 フード

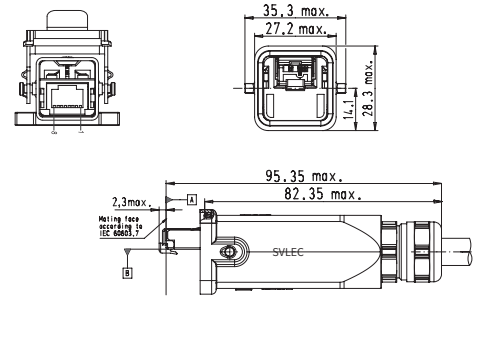

RJ45 オス

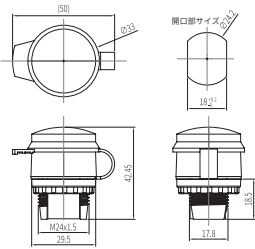

RJ45 プラグポート

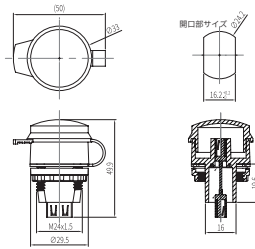

USB 3.0 コネクタ用

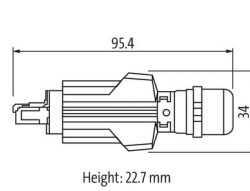

プッシュプル式 RJ45 コネクタ

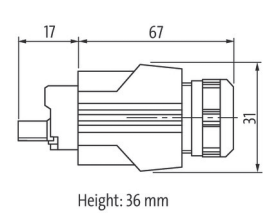

プッシュプル式電源コネクタ

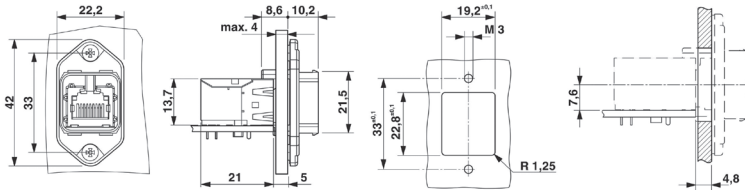

RJ45 コネクタハウジング

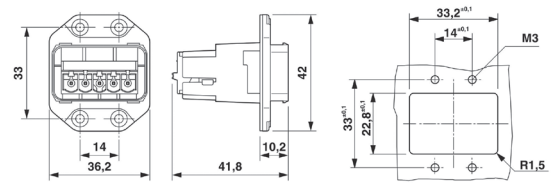

プッシュプル式電源ハウジング

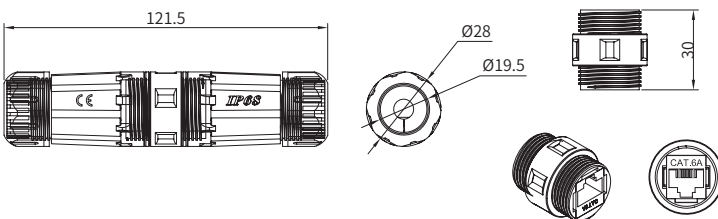

RJ45 防水コネクタ

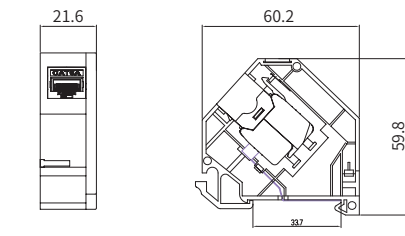

プッシュプル式 RJ45 コネクタ

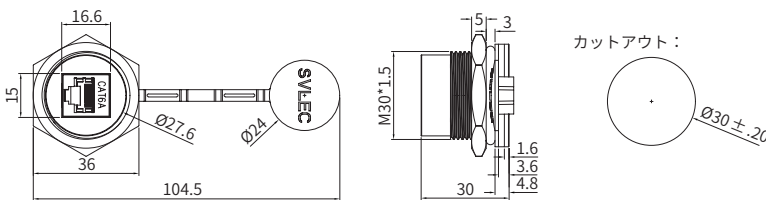

RJ45 ポートアダプター CAT6A

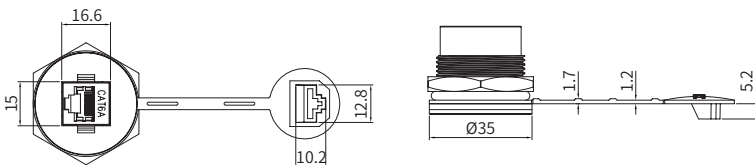

# PRESE DI SERVIZIO A PANNELLO Ø22

Panel mounting connectors Ø22 mm

Sistemi di connessione

Connection systems

Corpo in alluminio - plastica / Aluminium - plastic body  
Tappo IP65 incluso / IP65 cap included

IP65

RoHS  
COMPLIANT

CE



## Specifiche tecniche / Technical features

Diametro foratura Diameter cut-out	Materiale Material	Spessore Lamiera Panel thickness	Temperatura operativa Operative temperature	Umidità operativa Operating humidity	Velocità di trasmissione / transmission rating		
					USB2.0/USB Mini/ Micro - USB	USB 3.0	USB - C
22 mm	Metallo / Metal Plastica / Plastic	1 - 10 mm	-25 ... +55°C	45-85%RH	>30MB/s	>100MB/s	10GBps (5A fast charging)

MODELLI Model list	Tipo / fronte Type / front	Tipo / retro Type / back	Modello Model list	Codice Code	Descrizione Description
	RJ45 Cat.6 Femmina Female	RJ45 Cat.6 Femmina Female	PS-P22MR45	4302212185	Pres a pannello RJ45 cat.6 plastica F/F Panel RJ45 Cat.6 plastic connector F/F
	USB 3.0 Femmina Female	USB 3.0 Femmina Female	PS-P22PU3	4302212110	Pres a pannello USB 3.0 plastica F/F Panel USB 3.0 Cat.6 plastic connector F/F
	USB-B Femmina Female	USB-A Femmina Female	PS-P22PUB	4302212120	Pres a pannello USB-B plastica F/F (Retro USB-A) Panel USB-B plastic connector F/F (Rear USB-A)
	USB-C Femmina Female	USB 3.0 Femmina Female	PS-P22MUC	4302212150	Pres a pannello USB-C F/F Metallo (Retro USB 3.0) Panel USB-C metal connector F/F (Rear USB 3.0)
	USB-Mini 2.0 Femmina Female	USB-Mini 2.0 Maschio Male	PS-P22MMIU	4302212160	Pres a pannello USB-Mini F/M Metallo Panel USB-Mini metal connector F/M
	USB-Micro 2.0 Femmina Female	USB-Micro 2.0 Maschio Male	PS-P22MMOU	4302212170	Pres a pannello USB Micro F/M Metallo Panel USB-Micro metal connector F/M
	HDMI Femmina Female	HDMI Femmina Female	PS-P22MH	4302212190	Pres a pannello HDMI F/F Metallo Panel HDMI metal connector F/F
	2 x USB 2.0 Femmina Female	2 x USB 2.0 Femmina Female	PS-P22MU2X2	4302212300	Pres a pannello 2 x USB 2.0 F/F ø 22 mm in metallo Panel 2 x USB 2.0 metal connector F/F ø 22 mm
	-	-	PS-T22IP65	4302212200	Tappo nero IP65 per presa a pannello ø 22 mm Ip65 cap for panel mounting ø 22 mm

TAPPO COMPRESO NELLA FORNITURA DELLA PRESA A PANNELLO / PROTECTION CAP INCLUDED WITH THE PANEL CONNECTOR

Dimensionali e forature / Dimensions and holes

**RJ45 Cat.6 - Mod. PS-P22MR45**

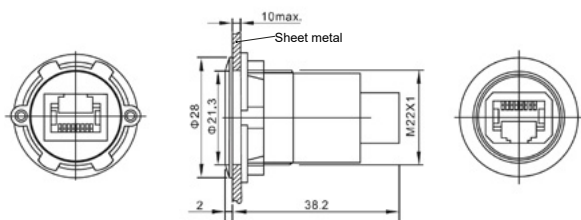

**USB-Mini 2.0 - Mod. PS-P22MMIU**

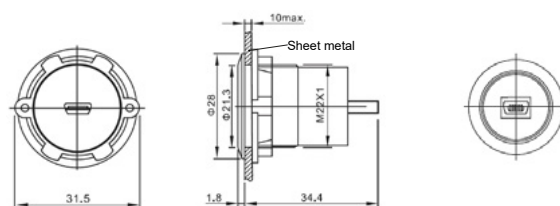

**USB 3.0 - Mod. PS-P22PU3**

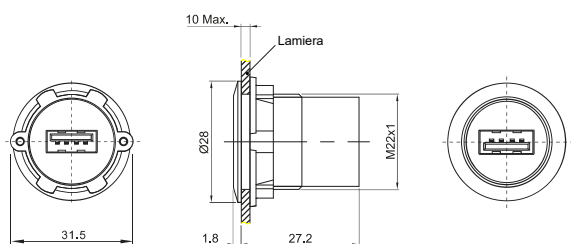

**USB-Micro 2.0 - Mod. PS-P22MMOU**

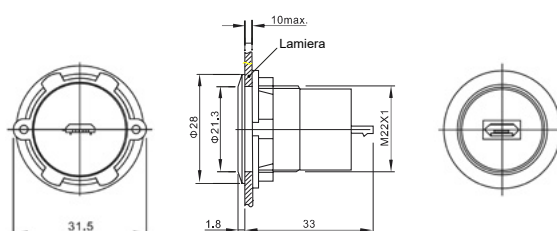

**USB-B - Mod. PS-P22PUB**

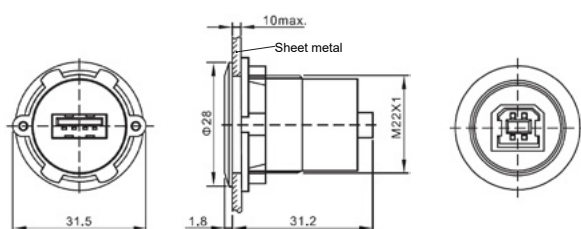

**HDMI - Mod. PS-P22MH**

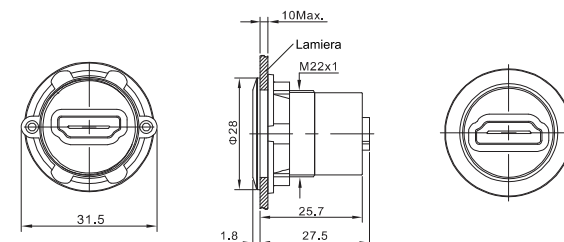

**USB-C - Mod. PS-P22MUC**

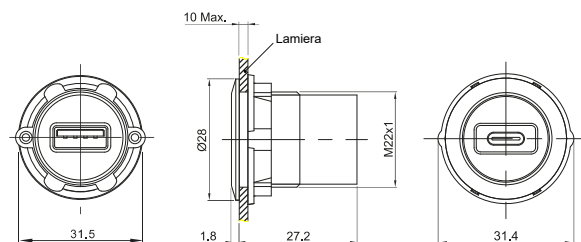

**2 x USB 2.0 - Mod. PS-P22MU2X2**

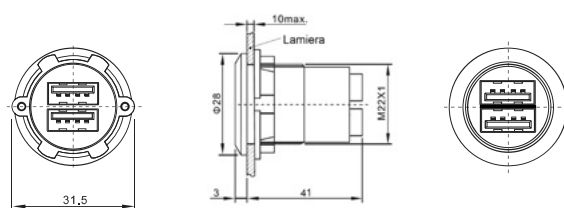

**TAPPO IP65 - Mod. PS-T22IP65**

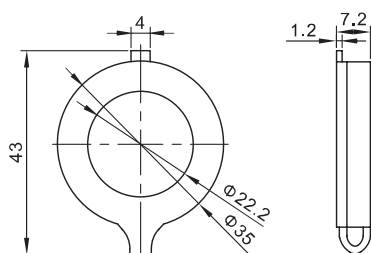

# PRESE DI SERVIZIO A PANNELLO Ø20 E Ø16

Panel mounting connectors Ø20 and Ø20



Sistemi di connessione  
Connection systems

Corpo in plastica / Plastic body  
Tappo IP67 incluso / IP67 cap included

IP67

RoHS  
COMPLIANT

CE



## Specifiche tecniche / Technical features

Diametro foratura <i>Diameter cut-out</i>	Materiale <i>Material</i>	Spessore Lamiera <i>Panel thickness</i>	Temperatura operativa <i>Operative temperature</i>	Umidità operativa <i>Operating humidity</i>	Velocità di trasmissione / <i>transmission rating</i>		
					USB2.0/USB Mini/ Micro - USB	USB 3.0	USB - C
20 e 16 mm	PA66	1 - 4 mm	-40 ... +80°C	45-85%RH	>30MB/s	>100MB/s	10GBps (5A fast charging)

MODELLI <i>Model list</i>	Tipo / fronte <i>Type / front</i>	Tipo / retro <i>Type / back</i>	Modello <i>Model list</i>	Codice <i>Code</i>	Descrizione <i>Description</i>
	Femmina / Female RJ45	Femmina / Female RJ45	PS-P20PR45	4302212480	Pres a pannello in plastica RJ45 cat.6a F/F <i>Panel RJ45 Cat.6a plastic connector F/F</i>
	Femmina / Female USB 3.0	Femmina / Female USB 3.0	PS-P20PU3	4302212410	Pres a pannello in plastica USB 3.0 F/F <i>Panel USB 3.0 plastic connector F/F</i>
	Femmina / Female HDMI	Maschio / Male HDMI	PS-P20PH	4302212490	Pres a pannello in plastica HDMI F/F <i>Panel HDMI plastic connector F/F</i>
	Femmina / Female USB-C	Femmina / Female USB-C	PS-P16PUC	4302212450	Pres a pannello in plastica USB-C F/F <i>Panel USB-C plastic connector F/F</i>

MODELLI <i>Model list</i>	Tipo / lato A <i>Type / side A</i>	Tipo / lato B <i>Type / side B</i>	Lunghezza <i>Length</i>	Codice <i>Code</i>	Modello <i>Model</i>	Descrizione <i>Description</i>
 NEW	Maschio / Male USB C	Maschio / Male USB 3.0	2 m	4302212455	PS-C16PUC320	Cavo USB-C M/M 2 m per PS-P16PUC <i>USB-C M/M cable 2 m for PS-P16PUC</i>
 NEW	Maschio / Male USB 3.0	Maschio / Male USB 3.0	2 m	4302212415	PS-C20PU320	Cavo USB3.0 M/M 2 m per PS-P20PU3 <i>USB3.0 M/M cable 2 m for PS-P20PU3</i>
 NEW		Cavo non incluso <i>Cable not included</i>		4302212475	PS-C20PR45	Custodia waterproof per cavo RJ45 standard per PS-P20PR45. Cavo non incluso. <i>Waterproof housing for RJ45 cable for PS-P20PR45. Cable not included.</i>

MODELLI Model list	Tipo / lato A Type / side A	Tipo / lato B Type / side B	Lunghezza Length	Codice Code	Descrizione Description
	Maschio / Male USB 3.0	Maschio / Male USB 3.0	0,5 m	3290701121	Cavo USB 3.0 prolunga tipo A/A maschio/maschio 0,5 m USB 3.0 extension cable type A/A male/male 0,5 m
			1 m	3290701122	Cavo USB 3.0 prolunga tipo A/A maschio/maschio 1 m USB 3.0 extension cable type A/A male/male 1 m
			1,8 m	3290701123	Cavo USB 3.0 prolunga tipo A/A maschio/maschio 1,8 m USB 3.0 extension cable type A/A male/male 1,8 m

### Dimensionali e forature / Dimensions and holes

#### RJ45 - Mod. PS-P20MR45

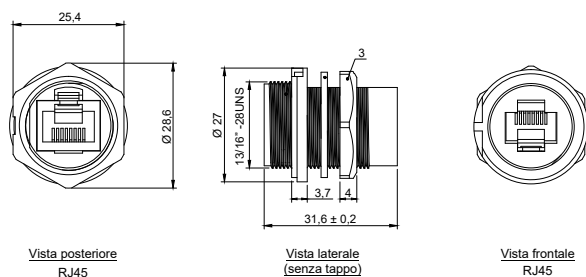

#### HDIM - Mod. PS-P20MH

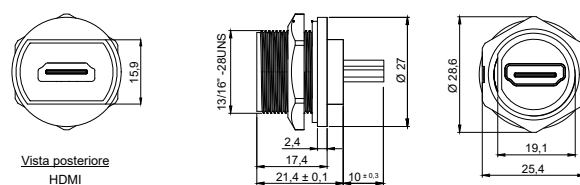

#### USB 3.0 - Mod. PS-P20PU3

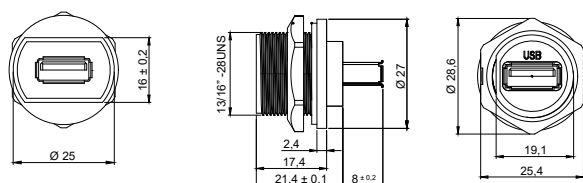

#### USB-C - Mod. PS-P16MUC

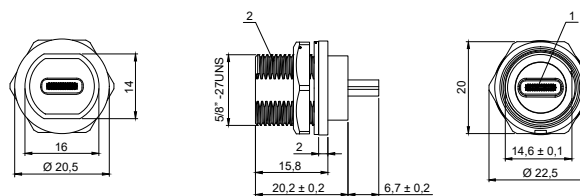

#### USB C - Mod. PS-C16PUC320

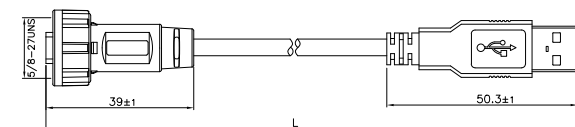

#### CUSTODIA / CASE - Mod. PS-C20PR45

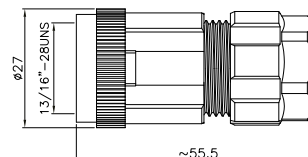

#### USB-C - Mod. PS-C20PU320

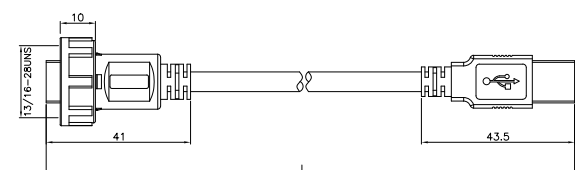

Altri modelli (cablaggi, esecuzioni speciali, ecc.) su richiesta / Other models (wiring, special versions, etc.) on request