

SPE Connectors



INDUSTRIAL
PARTNER
NETWORK



SPE Connectors

SPE Cable

Product figure



Scale diagram

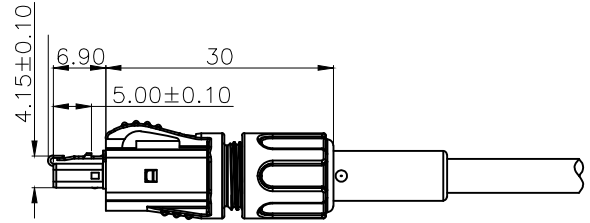

Contact layout/针孔排布 (Front view/前视图)

2pins
SPE



Order Data/订货信息

Contacts/芯数	Order No/订货号	P/N/料号
2pins	940000-00-466	—

Specifications/技术参数

Number of contacts/芯数	2pins	
Termination/接线方式	crimp/压接	刺破/IDC
Wire gauge/线规	0.14mm ² (26AWG)	
Operating temperature/工作温度	-25°C ~ +80°C	
Mechanical operation/插拔次数	> 100 mating cycles	
Rated voltage/额定电压	60V	
Rated current (40°C)/额定电流	4A	
Protection degree/防护等级	IP20	
Contact resistance/接触电阻	≤20mΩ	
Insulation resistance/绝缘电阻	≥500MΩ	
Pin contact/插针材料	CuZn	
Socket contact/插孔材料	CuSn	
Contact plating/针孔镀层材料	Au	

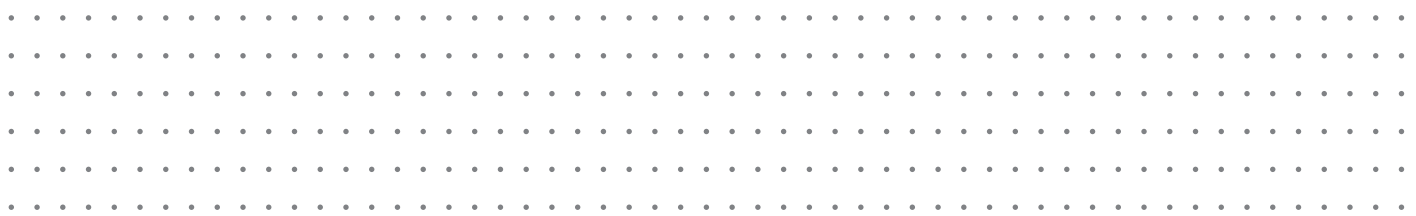

M5
M8
M9
M12
M16
M17
M23
7/8
RD24
D-B
NMEA
D-Sub
USB
RF
P-P

SPE Socket

Product figure



Scale diagram

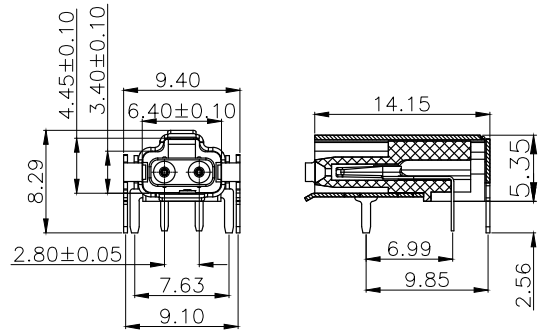

Contact layout/针孔排布 (Front view/前视图)

2pins
SPE

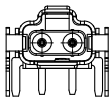

Order Data/订货信息

Contacts/芯数	Order No/订货号	P/N/料号
2pins	940000-00-467	—

Specifications/技术参数

Number of contacts/芯数	2pins
Operating temperature/工作温度	-25°C ~ +85°C
Mechanical operation/插拔次数	> 100 mating cycles
Rated voltage/额定电压	60V
Rated current (40°C)/额定电流	4A
Protection degree/防护等级	IP20
Contact resistance/接触电阻	≤20mΩ
Insulation resistance/绝缘电阻	≥500MΩ
Pin contact/插针材料	CuZn
Socket contact/插孔材料	CuSn
Contact plating/针孔镀层材料	Au

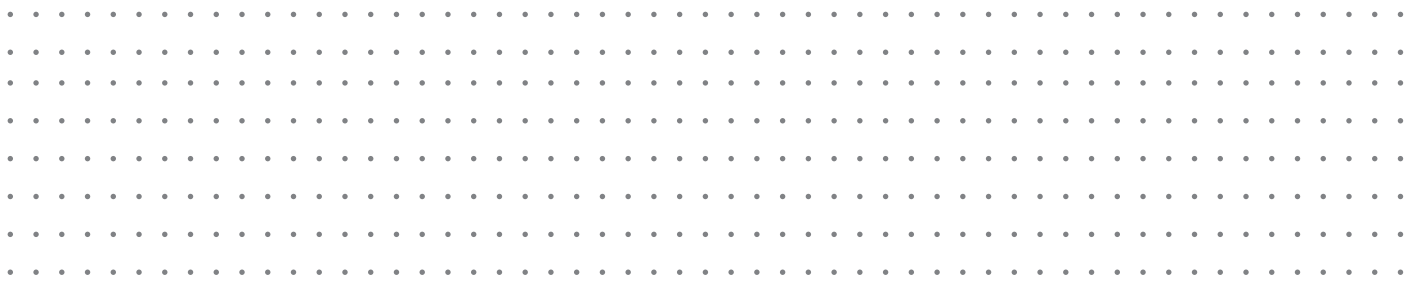

SPE Cable

Product figure



Scale diagram

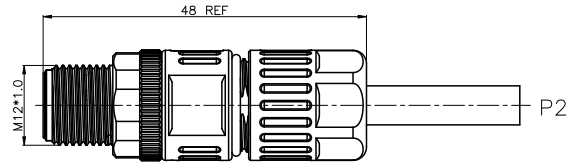

Contact layout/针孔排布 (Front view/前视图)

2pins
SPE



Order Data/订货信息

Contacts/芯数	Order No/订货号	P/N/料号
2pins	930002-01-001	—

Specifications/技术参数

Number of contacts/芯数	2pins
Termination/接线方式	crimp/压接
Cable OD/线材直径	4~6mm
Operating temperature/工作温度	-40°C ~ +85°C
Mechanical operation/插拔次数	> 100 mating cycles
Rated voltage/额定电压	60V
Rated current (40°C)/额定电流	4A
Protection degree/防护等级	IP67
Contact resistance/接触电阻	≤20mΩ
Insulation resistance/绝缘电阻	≥500MΩ
Pin contact/插针材料	CuZn
Socket contact/插孔材料	CuSn
Contact plating/针孔镀层材料	Au

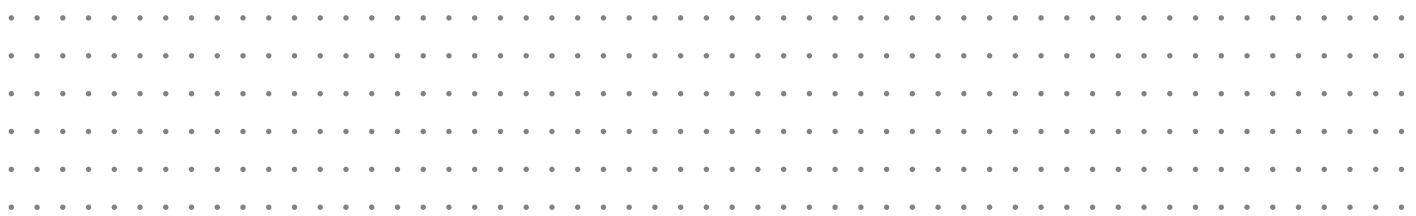

M5
M8
M9
M12
M16
M17
M23
7/8
RD24
D-B
NMEA
D-Sub
USB
RF
P-P

SPE Socket

Product figure



Scale diagram

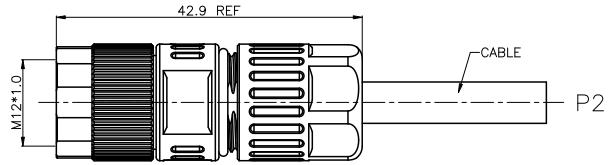

Contact layout/针孔排布 (Front view/前视图)

2pins
SPE



Order Data/订货信息

Contacts/芯数	Order No/订货号	P/N/料号
2pins	930002-02-001	—

Specifications/技术参数

Number of contacts/芯数	2pins
Termination/接线方式	crimp/压接
Cable OD/线材直径	4~6mm
Operating temperature/工作温度	-40°C ~ +85°C
Mechanical operation/插拔次数	> 100 mating cycles
Rated voltage/额定电压	60V
Rated current (40°C)/额定电流	4A
Protection degree/防护等级	IP67
Contact resistance/接触电阻	≤20mΩ
Insulation resistance/绝缘电阻	≥500MΩ
Pin contact/插针材料	CuZn
Socket contact/插孔材料	CuSn
Contact plating/针孔镀层材料	Au

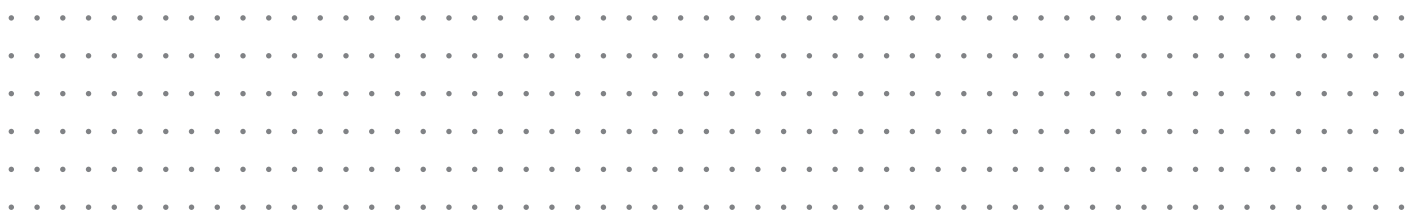

- M5
- M8
- M9
- M12
- M16
- M17
- M23
- 7/8
- RD24
- D-B
- NMEA
- D-Sub
- USB
- RF
- P-P

SPE Adapter connector

Product figure



Scale diagram

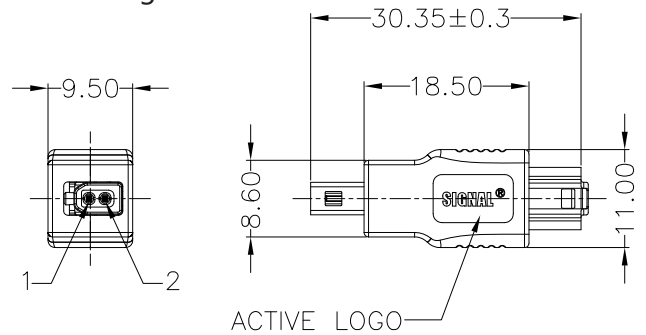

Contact layout/针孔排布 (Front view/前视图)

2pins
SPE

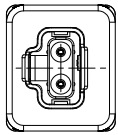

Order Data/订货信息

Contacts/芯数	Order No/订货号	P/N/料号
2pins	930002-10-001	—

Specifications/技术参数

Number of contacts/芯数	2pins
Operating temperature/工作温度	-25°C ~ +85°C
Mechanical operation/插拔次数	> 100 mating cycles
Rated voltage/额定电压	60V
Rated current (40°C)/额定电流	4A
Protection degree/防护等级	IP20
Contact resistance/接触电阻	≤20mΩ
Insulation resistance/绝缘电阻	≥500MΩ
Pin contact/插针材料	CuZn
Socket contact/插孔材料	CuSn
Contact plating/针孔镀层材料	Au

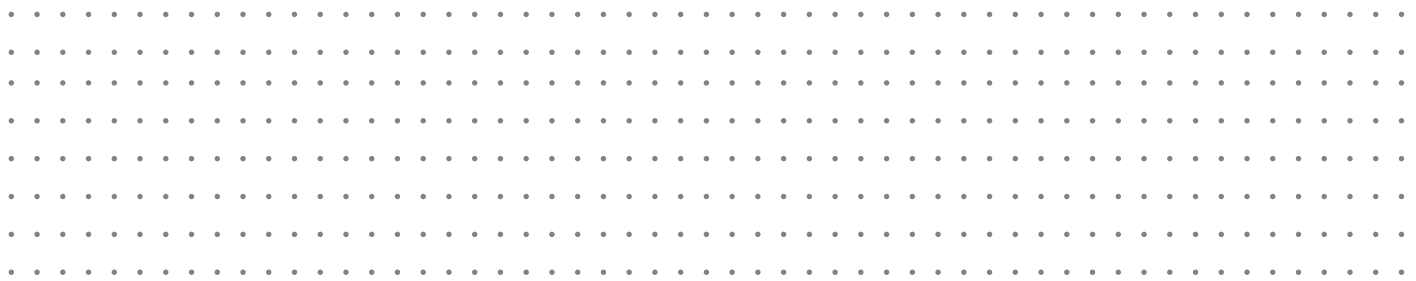

M5
M8
M9
M12
M16
M17
M23
7/8
RD24
D-B
NMEA
D-Sub
USB
RF
P-P